

3-TERMINAL POSITIVE VOLTAGE REGULATOR

■ GENERAL DESCRIPTION

The NJM78M00S is a 0.5A output 3-Terminal Positive Voltage Regulator.

It has improvements in contrast with a conventional NJM78M00:

An output voltage accuracy, an operating temperature range and MLCC correspondence.

■ PACKAGE OUTLINE

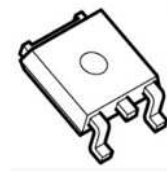

NJM78M00SDL1
(TO-252-3)

■ FEATURES

- Output Current 0.5A max.
- Output Voltage Accuracy $V_O \pm 3.0\%$
- High Ripple Rejection
- Correspond to Low ESR Capacitor (MLCC)
- Over Current Protection Circuit
- Thermal Shutdown Circuit
- Output Voltage Lineup 5V, 9V, 12V, 15V
- Package TO-252-3

■ PIN CONFIGURATION

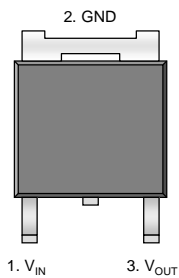

■ EQUIVALENT CIRCUIT

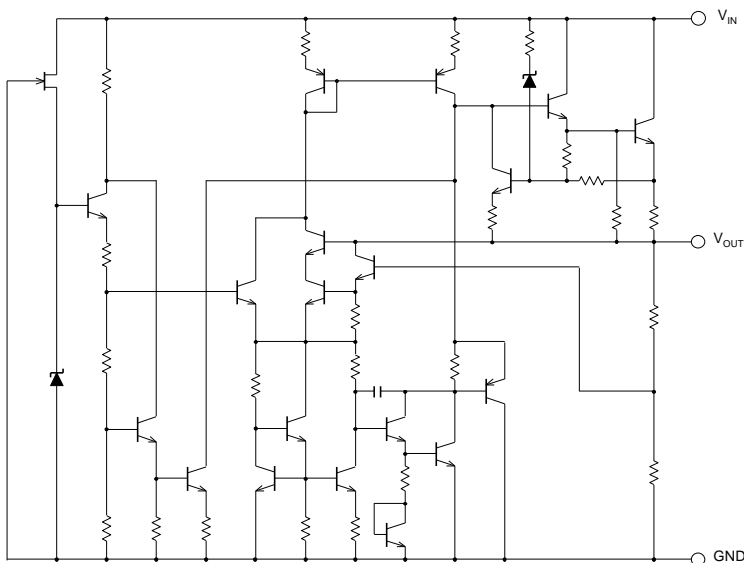

NJM78M00S

■ ABSOLUTE MAXIMUM RATINGS

(Unless otherwise noted, $T_a = 25^\circ\text{C}$)

PARAMETER	SYMBOL	MAXIMUM RATINGS	UNIT
Input Voltage	V_{IN}	35	V
Power Dissipation	P_D	1190 (*1) 3125 (*2)	mW
Junction Temperature Range	T_j	- 40 to + 150	$^\circ\text{C}$
Operating Temperature Range	T_{opr}	- 40 to + 125	$^\circ\text{C}$
Storage Temperature Range	T_{stg}	- 50 to + 150	$^\circ\text{C}$

(*1) Mounted on glass epoxy board. (76.2×114.3×1.6mm:EIA/JDEC standard size, 2Layers, copper area 100mm²)

(*2) Mounted on glass epoxy board. (76.2×114.3×1.6mm:EIA/JDEC standard size, 4Layers)

(4Layers inner foil: 74.2 ×74.2mm applying a thermal via hole to a board based on JEDEC standard JESD51-5)

■ ELECTRICAL CHARACTERISTICS

($C_{IN}=0.33\mu\text{F}$, $C_O=0.1\mu\text{F}$, $T_f=25^\circ\text{C}$) Measurement is to be conducted is pulse testing.

PARAMETER	SYMBOL	TEST CONDITION	MIN.	TYP.	MAX.	UNIT
NJM78M05SDL1						
Output Voltage	V_O	$V_{IN}=10\text{V}$, $I_O=0.35\text{A}$	4.85	5.0	5.15	V
Line Regulation	$\Delta V_O/V_{IN}$	$V_{IN}=7\text{V}$ to 25V, $I_O=0.2\text{A}$	-	3	50	mV
Load Regulation	$\Delta V_O/I_O$	$V_{IN}=10\text{V}$, $I_O=0.005\text{A}$ to 0.5A	-	5	50	mV
Quiescent Current	I_Q	$V_{IN}=10\text{V}$, $I_O=0\text{mA}$	-	4	6.0	mA
Average Temperature Coefficient of Output Voltage	$\Delta V_O/\Delta T$	$V_{IN}=10\text{V}$, $I_O=5\text{mA}$	-	-0.5	-	mV/ $^\circ\text{C}$
Ripple Rejection	RR	$V_{IN}=10\text{V}$, $I_O=0.35\text{A}$, $e_{in}=1V_{P-P}$, $f=120\text{Hz}$	60	80	-	dB
Output Noise Voltage	V_{NO}	$V_{IN}=10\text{V}$, BW=10Hz to 100kHz, $I_O=0.35\text{A}$	-	60	-	μVrms
Dropout Voltage	ΔV_{IO}	$I_O=0.5\text{A}$	-	1.8	-	V

NJM78M09SDL1

Output Voltage	V_O	$V_{IN}=15\text{V}$, $I_O=0.35\text{A}$	8.73	9.0	9.27	V
Line Regulation	$\Delta V_O/V_{IN}$	$V_{IN}=11.5\text{V}$ to 25V, $I_O=0.2\text{A}$	-	6	60	mV
Load Regulation	$\Delta V_O/I_O$	$V_{IN}=15\text{V}$, $I_O=0.005\text{A}$ to 0.5A	-	8	90	mV
Quiescent Current	I_Q	$V_{IN}=15\text{V}$, $I_O=0\text{mA}$	-	4.1	6.0	mA
Average Temperature Coefficient of Output Voltage	$\Delta V_O/\Delta T$	$V_{IN}=15\text{V}$, $I_O=5\text{mA}$	-	-0.9	-	mV/ $^\circ\text{C}$
Ripple Rejection	RR	$V_{IN}=15\text{V}$, $I_O=0.35\text{A}$, $e_{in}=1V_{P-P}$, $f=120\text{Hz}$	56	70	-	dB
Output Noise Voltage	V_{NO}	$V_{IN}=15\text{V}$, BW=10Hz to 100kHz, $I_O=0.35\text{A}$	-	90	-	μVrms
Dropout Voltage	ΔV_{IO}	$I_O=0.5\text{A}$	-	1.8	-	V

■ ELECTRICAL CHARACTERISTICS

($C_{IN}=0.33\mu\text{F}$, $C_O=0.1\mu\text{F}$, $T_f=25^\circ\text{C}$) Measurement is to be conducted is pulse testing.

PARAMETER	SYMBOL	TEST CONDITION	MIN.	TYP.	MAX.	UNIT
NJM78M12SDL1						
Output Voltage	V_O	$V_{IN}=19\text{V}$, $I_O=0.35\text{A}$	11.64	12.0	12.36	V
Line Regulation	ΔV_O-V_{IN}	$V_{IN}=14.5\text{V}$ to 30V , $I_O=0.2\text{A}$	-	8	60	mV
Load Regulation	ΔV_O-I_O	$V_{IN}=19\text{V}$, $I_O=0.005\text{A}$ to 0.5A	-	8	120	mV
Quiescent Current	I_Q	$V_{IN}=19\text{V}$, $I_O=0\text{mA}$	-	4.1	6.0	mA
Average Temperature Coefficient of Output Voltage	$\Delta V_O/\Delta T$	$V_{IN}=19\text{V}$, $I_O=5\text{mA}$	-	-1.2	-	mV/°C
Ripple Rejection	RR	$V_{IN}=19\text{V}$, $I_O=0.35\text{A}$, $e_{in}=1\text{V}_{P.P.}$, $f=120\text{Hz}$	55	70	-	dB
Output Noise Voltage	V_{NO}	$V_{IN}=19\text{V}$, BW=10Hz to 100kHz, $I_O=0.35\text{A}$	-	100	-	μVrms
Dropout Voltage	ΔV_{IO}	$I_O=0.5\text{A}$	-	1.8	-	V

NJM78M15SDL1						
Output Voltage	V_O	$V_{IN}=23\text{V}$, $I_O=0.35\text{A}$	14.55	15.0	15.45	V
Line Regulation	ΔV_O-V_{IN}	$V_{IN}=17.5\text{V}$ to 30V , $I_O=0.2\text{A}$	-	10	60	mV
Load Regulation 1	ΔV_O-I_O	$V_{IN}=23\text{V}$, $I_O=0.005\text{A}$ to 0.5A	-	10	150	mV
Quiescent Current	I_Q	$V_{IN}=23\text{V}$, $I_O=0\text{mA}$	-	4.1	6.0	mA
Average Temperature Coefficient of Output Voltage	$\Delta V_O/\Delta T$	$V_{IN}=23\text{V}$, $I_O=5\text{mA}$	-	-1.5	-	mV/°C
Ripple Rejection	RR	$V_{IN}=23\text{V}$, $I_O=0.35\text{A}$, $e_{in}=1\text{V}_{P.P.}$, $f=120\text{Hz}$	54	70	-	dB
Output Noise Voltage	V_{NO}	$V_{IN}=23\text{V}$, BW=10Hz to 100kHz, $I_O=0.35\text{A}$	-	120	-	μVrms
Dropout Voltage	ΔV_{IO}	$I_O=0.5\text{A}$	-	1.8	-	V

NJM78M00S

■ TEST CIRCUIT

1. Output Voltage, Line Regulation, Load Regulation, Quiescent Current, Average, Output Noise Voltage, Temperature Coefficient of Output Voltage, Peak Output/Short Circuit Current

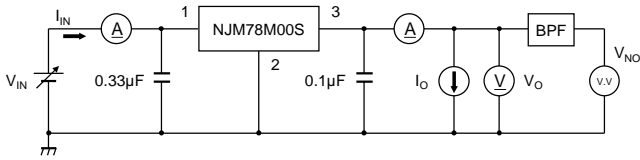

- Measurement is to be conducted in pulse testing
- $I_Q = I_{IN} - I_O$

2. Ripple Rejection

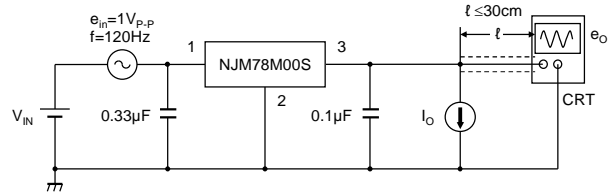

$$RR = 20 \log_{10} \left(\frac{e_{in}}{e_o} \right)$$

• Input Capacitor C_{IN}

Input Capacitor C_{IN} is required to prevent oscillation and reduce power supply ripple for applications when high power supply impedance or a long power supply line.

Therefore, use the recommended C_{IN} value (refer to conditions of ELECTRIC CHARACTERISTIC) or larger and should connect between GND and V_{IN} as shortest path as possible to avoid the problem.

• Output Capacitor C_O

Output capacitor (C_O) will be required for a phase compensation of the internal error amplifier.

The capacitance and the equivalent series resistance (ESR) influence to stable operation of the regulator.

Use of a smaller C_O may cause excess output noise or oscillation of the regulator due to lack of the phase compensation.

On the other hand, Use of a larger C_O reduces output noise and ripple output, and also improves output transient response when rapid load change.

Therefore, use the recommended C_O value (refer to conditions of ELECTRIC CHARACTERISTIC) or larger and should connect between GND and V_{OUT} as shortest path as possible for stable operation.

In addition, you should consider varied characteristics of capacitor (a frequency characteristic, a temperature characteristic, a DC bias characteristic and so on) and unevenness peculiar to a capacitor supplier enough.

When selecting C_O , recommend that have withstand voltage margin against output voltage and superior temperature characteristic though this product is designed stability works with wide range ESR of capacitor including low ESR products.

■ THERMAL RESISTANCE CHARACTERISTICS

PARAMETER	SYMBOL	VALUE	UNIT
Junction-to-Ambient Thermal Resistance	θ_{ja}	105 (*1)	°C/W
		40 (*2)	
Junction-to-Top of Package Characterization Parameter	ψ_{jt}	17 (*1)	°C/W
		12 (*2)	

(*1) Mounted on glass epoxy board. (76.2×114.3×1.6mm:EIA/JDEC standard size, 2Layers, copper area 100mm²)

(*2) Mounted on glass epoxy board. (76.2×114.3×1.6mm:EIA/JDEC standard size, 4Layers)

(4Layers inner foil: 74.2 ×74.2mm applying a thermal via hole to a board based on JEDEC standard JESD51-5)

■ AMBIENT TEMPERATURE vs. POWER DISSIPATION

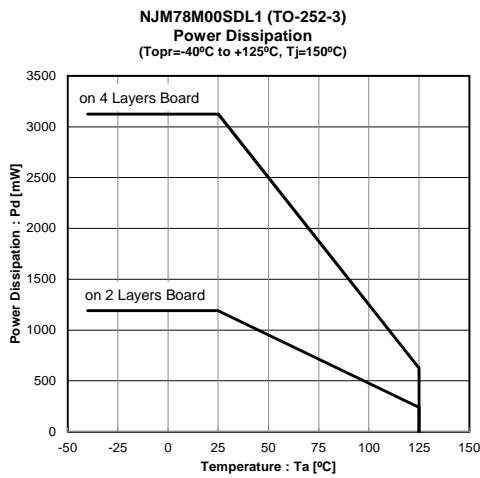

(*1) Mounted on glass epoxy board. (76.2×114.3×1.6mm:EIA/JDEC standard size, 2Layers, copper area 100mm²)

(*2) Mounted on glass epoxy board. (76.2×114.3×1.6mm:EIA/JDEC standard size, 4Layers)

(4Layers inner foil: 74.2 ×74.2mm applying a thermal via hole to a board based on JEDEC standard JESD51-5)

NJM78M00S

■ TYPICAL CHARACTERISTICS (5V)

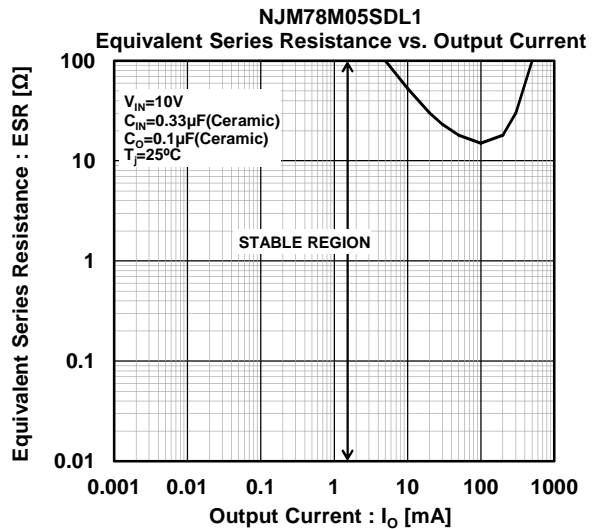
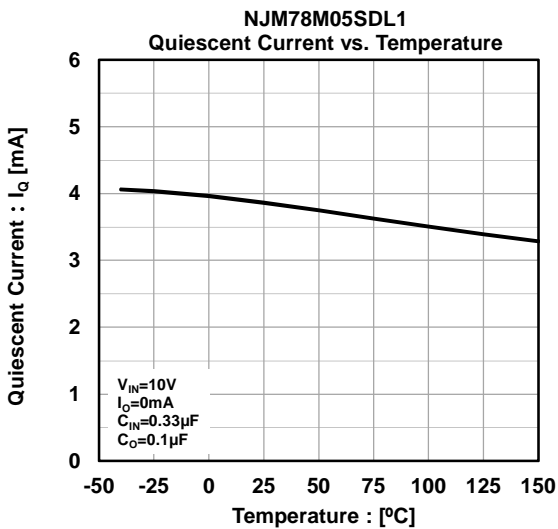
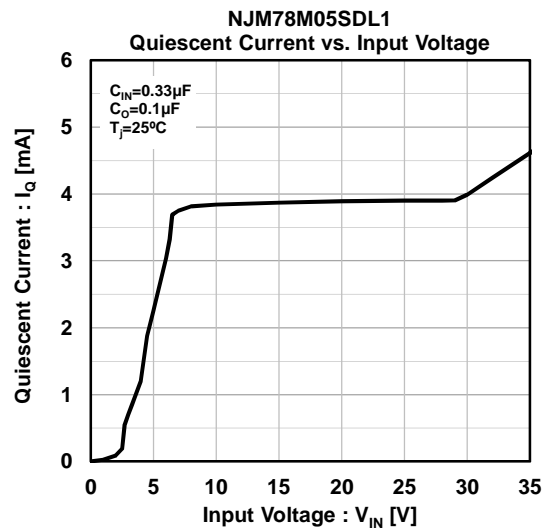
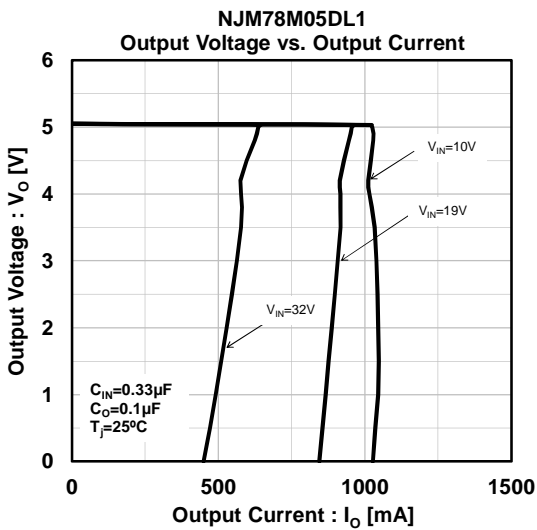
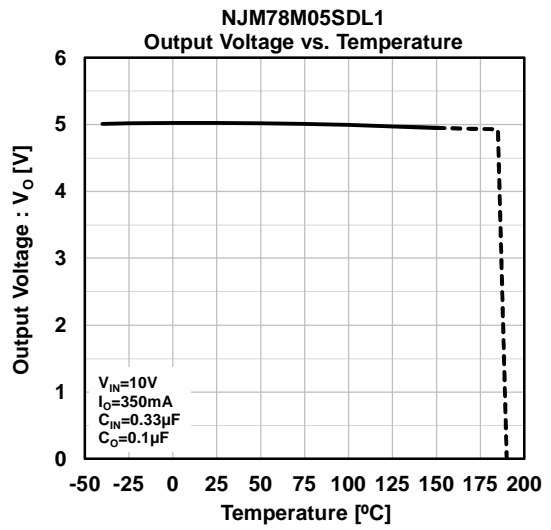
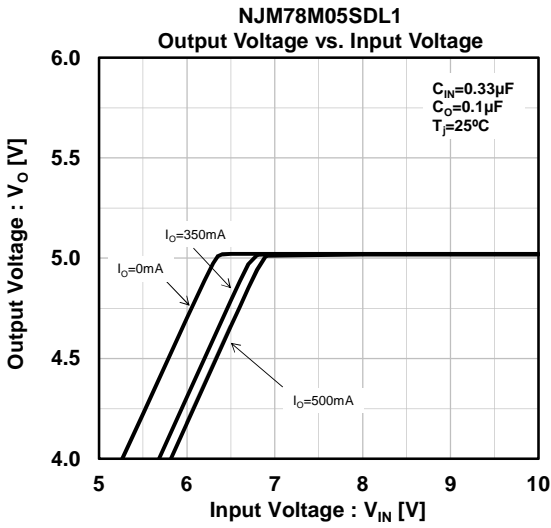

■ TYPICAL CHARACTERISTICS (5V)

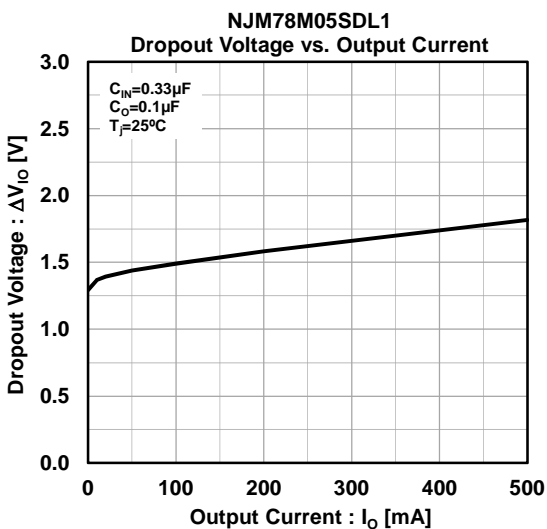
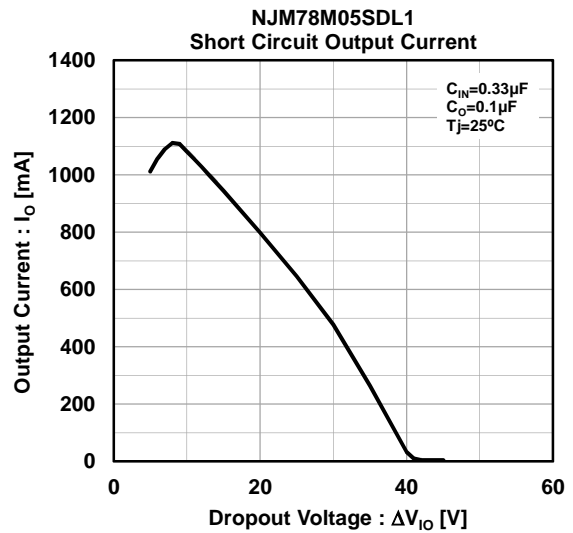
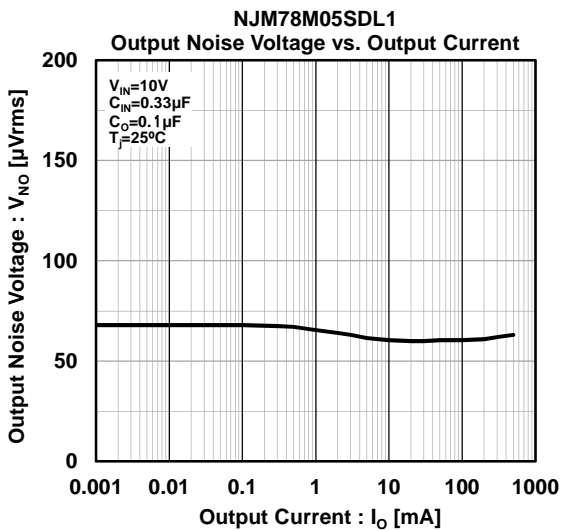
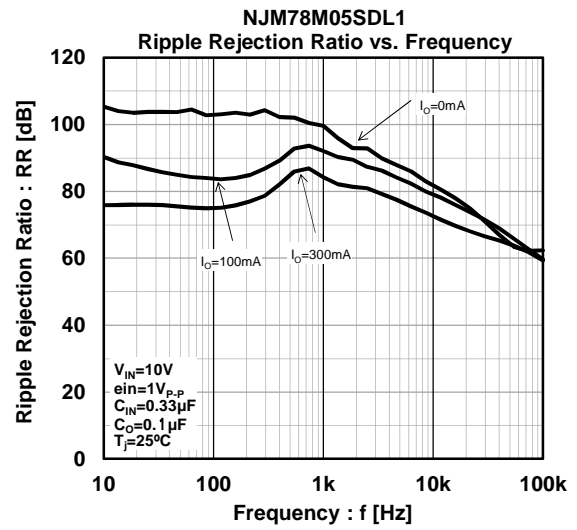
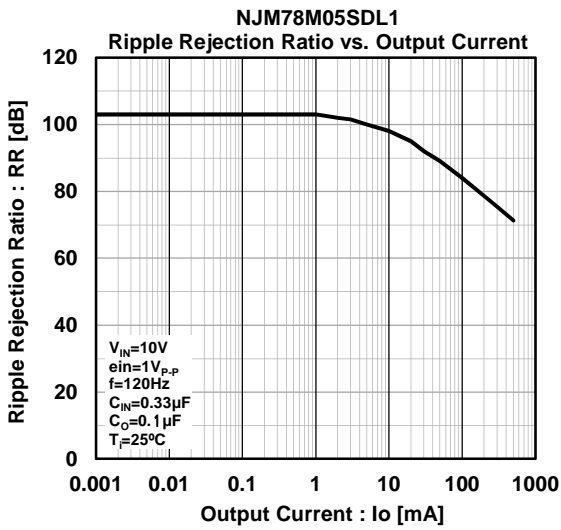

NJM78M00S

■ TYPICAL CHARACTERISTICS (15V)

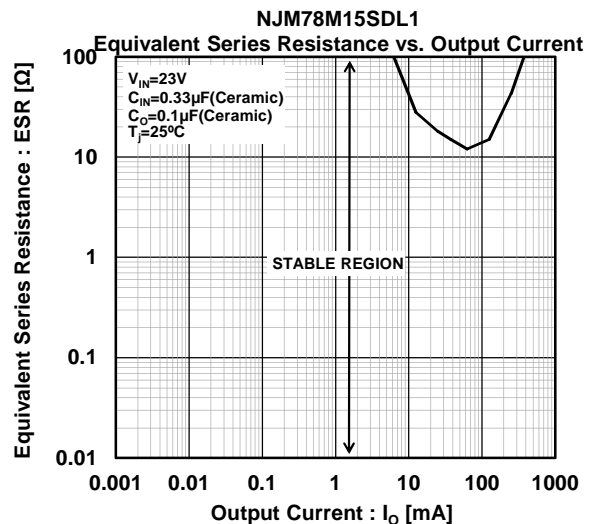
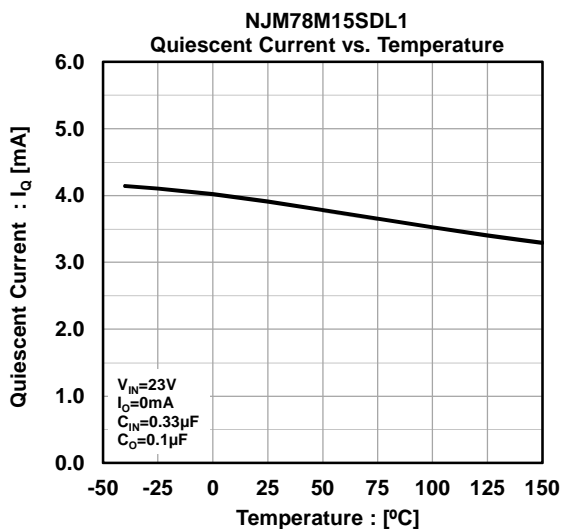
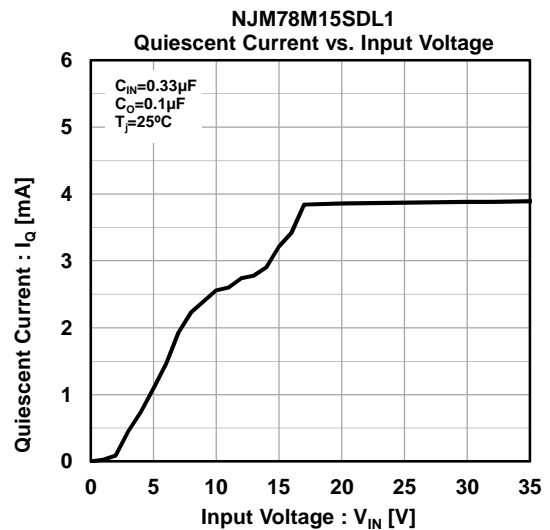
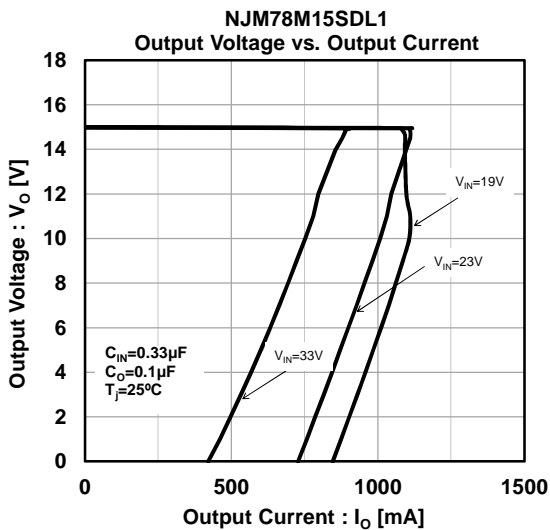
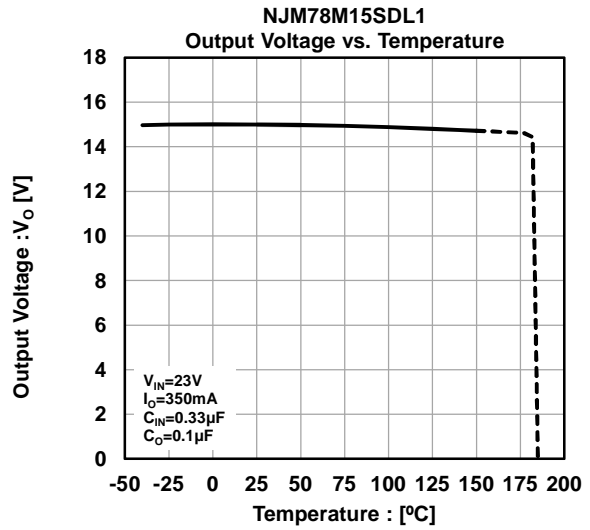
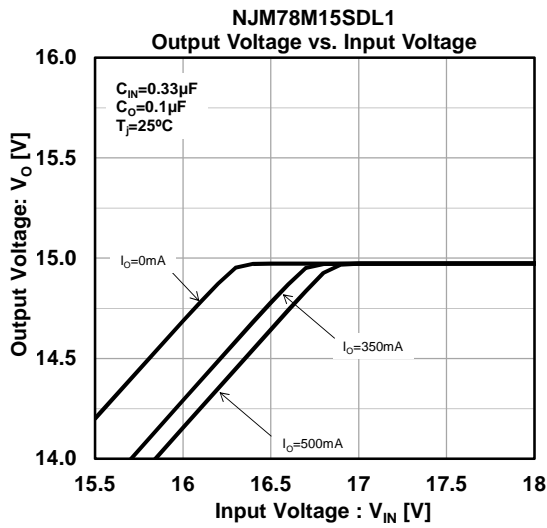

■ TYPICAL CHARACTERISTICS (15V)

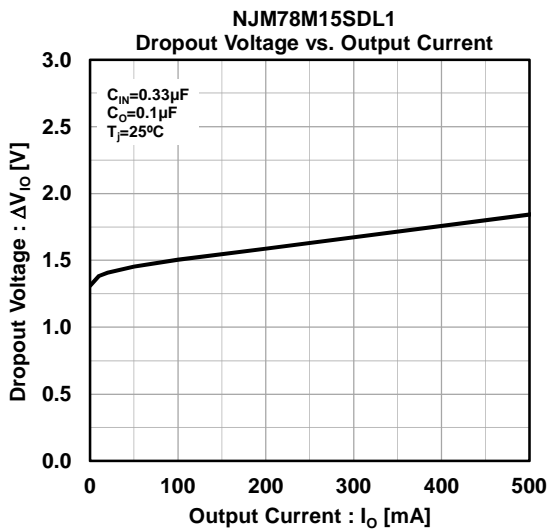
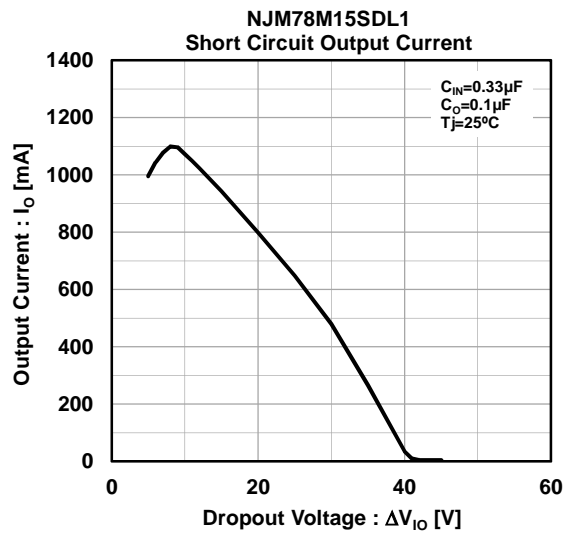
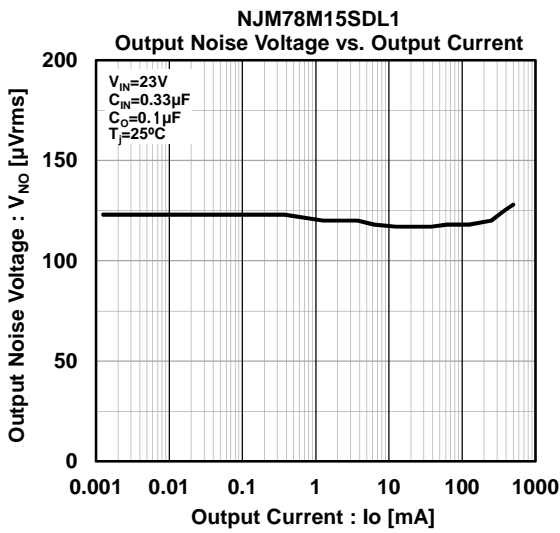
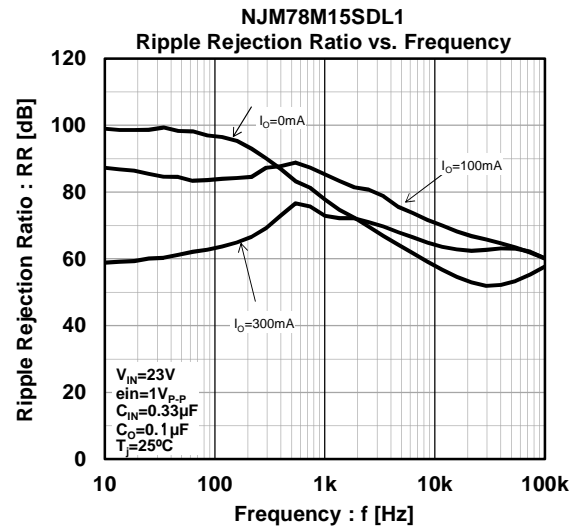
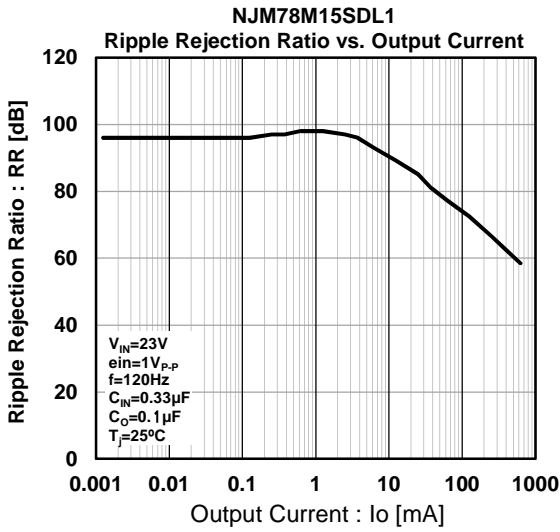

NJM78M00S

MEMO

[CAUTION]
The specifications on this databook are only given for information, without any guarantee as regards either mistakes or omissions. The application circuits in this databook are described only to show representative usages of the product and not intended for the guarantee or permission of any right including the industrial rights.